

TR Series Angle Power Strip

Tamper Resistant Receptacles eliminate cutouts for receptacles and switches in your backsplash

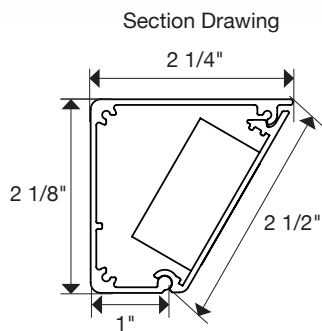

FEATURES

- Tamper Resistant
- Easy Installation
- Designer finishes to blend with any decor
- 3-Year Limited Warranty
- Custom options include: USB Ports, Phone Jacks, Cable Jacks, Data Ports. See pg. 36 for more options.

APPLICATIONS

- Kitchens
- Baths
- Offices & Computer Labs
- Islands
- Shops & Garages

SPECIFICATIONS

Construction Materials: Powder Coated Aluminum

Input Voltage: 120V

Mounting: Wood Screws & Wall Anchors

Wiring: 12 ga. Romex

Environment: Dry Only

TR SERIES ANGLE POWER STRIP

Part Number	Length	# of Duplex Recept.	Recept. Color	Finish
TR9-1ColorD-P-Finish	9"	1	B, G, W	BK, BZ, SN, WT
TR12-1ColorD-P-Finish	12"	1	B, G, W	BK, BZ, SN, WT
TR18-2ColorD-P-Finish	18"	2	B, G, W	BK, BZ, SN, WT
TR24-2ColorD-P-Finish	24"	2	B, G, W	BK, BZ, SN, WT
TR30-2ColorD-P-Finish	30"	2	B, G, W	BK, BZ, SN, WT
TR36-2ColorD-P-Finish	36"	2	B, G, W	BK, BZ, SN, WT
TR42-3ColorD-P-Finish	42"	3	B, G, W	BK, BZ, SN, WT
TR48-3ColorD-P-Finish	48"	3	B, G, W	BK, BZ, SN, WT
TR60-4ColorD-P-Finish	60"	4	B, G, W	BK, BZ, SN, WT
TR72-4ColorD-P-Finish	72"	4	B, G, W	BK, BZ, SN, WT

FINISHES



Black (BK)



Bronze (BZ)



Satin Nickel (SN)



White (WT)

RECEPTACLE COLORS



Black (B)



Gray (G)



White (W)

OPTIONAL INSTALLATION COMPONENTS

PART NUMBER	DIMENSIONS	DESCRIPTION
TR-SQ-JB-P-Finish	3" x 3" x 2 1/8"	Square Junction Box



TR Series Angle Power Strip

Tamper Resistant Receptacles eliminate cutouts for receptacles and switches in your backsplash

TR72-4ColorD-Finish

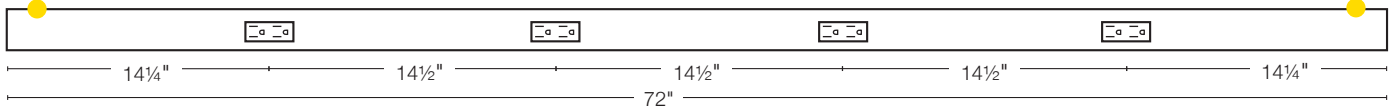

TR60-4ColorD-Finish

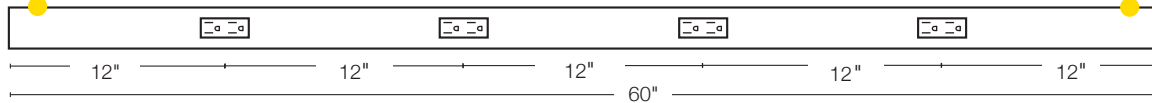

TR48-3ColorD-Finish

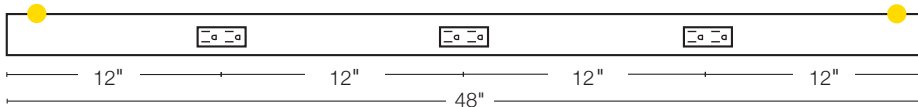

TR42-3ColorD-Finish

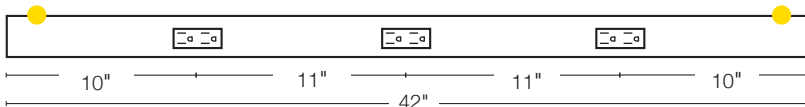

TR36-2ColorD-Finish

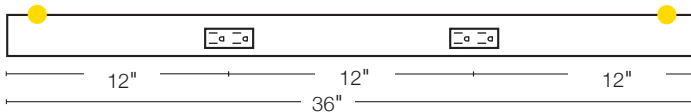

TR30-2ColorD-Finish

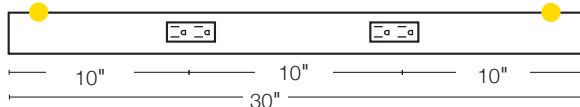

TR24-2ColorD-Finish

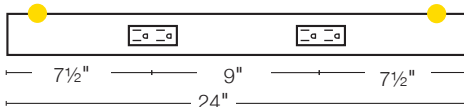

TR18-2ColorD-Finish

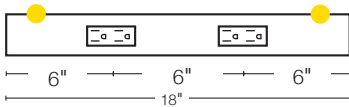

TR12-1ColorD-Finish

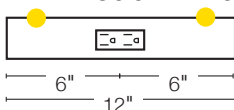

TR9-1ColorD-Finish

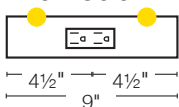

LEGEND

= Knock-out (all knock-outs are 1 1/2" from end)

= Receptacle (15A receptacle standard)

CUSTOM OPTIONS

- Custom lengths from 7" - 92" (larger sizes will have a seam when assembled)
- Additional devices (see next page)
- Custom device placement

CUSTOM OPTION DETAILS

- Receptacles must be a minimum of 5" apart (on center)
- Receptacles must be a minimum of 3" from end
- Custom charges will apply, call for a quote and assistance with your custom order
- Call for lead time



TR Series Angle Power Strip

Switches



TRO-DS-2SPS-W



TRO-3WS, TRO-4WS,
TRO-SPS

Receptacles



TRO-15A-REC



TRO-20A-REC

Combination Devices



TRO-USB/REC



TRO-CB-1P/REC
& TRO-CB-3P/REC

Connectors



TRO-PJ



TRO-CJ



TRO-HDMI

Port Frames



TRO-2PORT, TRO-3PORT, TRO-4PORT & TRO-6PORT

Snap-in Connectors



TRO-CON-CJ



TRO-CON-PJ



TRO-CON-CAT5E

Power Supply



TRO-TLD-D30WSO
TRO-TLD-D45WSO
TRO-TLD-D60WSO
TRO-TLD-D75WSO

TR SERIES CUSTOM OPTIONS

CUSTOM LENGTHS

Custom lengths to the 1/4" from 9" - 92" (larger sizes will have a seam when assembled)

SWITCHES

PART NUMBER	DESCRIPTION	COLOR
TRO-SPS-Color	Decora single-pole rocker switch	B, G, W
TRO-SPS-20A-Color	Decora 20 Amp single-pole rocker switch	B, G, W
TRO-3WS-Color	Decora 3-way rocker switch	B, G, W
TRO-3WS-20A-Color	Decora 20 Amp 3-way rocker switch	B, G, W
TRO-4WS-Color	Decora 4-way rocker switch	B, G, W
TRO-DS-2SPS-Color	Decora double switch	B, G, W
TRO-DS-(2)3WS-Color	Double switch with (2) 3-way	B, W
TRO-DS-1P/3P-Color	Double switch with single-pole & 3-way	B, G, W
TRO-TS-3SPS-Color	Decora triple switch w/ three single-pole switches	B, W

RECEPTACLES

TRO-15A-REC	15 Amp tamper resistant receptacle	B, G, W
TRO-20A-REC	20 Amp tamper resistant receptacle	B, G, W

RECEPTACLES/SWITCH COMBO

TRO-USB/REC	Combination (2) USB ports and receptacle	B, G, W
TRO-CB-1P/REC-Color	Combination single-pole switch and receptacle	B, G, W
TRO-CB-3P/REC-Color	Combination 3-way switch & receptacle	B, G, W

CONNECTORS

TRO-CJ-Color	Decora style Cable Jack, "F" Style, for 75 Ohm coaxial cable	B, G, W
TRO-PJ-Color	Decora style 6 conductor telephone jack	B, G, W
TRO-HDMI-Color	HDMI Port Connector	W

PORT FRAMES

TRO-2PORT-Color	Decora style multimedia insert. Allows you to combine your choice of 2, 3, 4, or 6 voice, data, audio, or video connectors into one compact, attractive wallplate	B, G, W
TRO-3PORT-Color		
TRO-4PORT-Color		
TRO-6PORT-Color		

SNAP-IN CONNECTORS

TRO-CON-BLANK-Color	Blank insert used to cover up any unused openings in any of the Port Frames	B, G, W
TRO-CON-CAT5e-Color	Snap-in Data Category 5e 8-conductor channel-rated connector. 100 MHz	B, G, W
TRO-CON-CAT6-Color	Snap-in Data Category 6 8-conductor component-rated connector. 250 MHz	B, G, W
TRO-CON-PJ-8-Color	6-conductor USOC voice grade phone (jack) connector	B, G, W

POWER SUPPLIES

TRO-TLD-D30WSO	30W hardwire 15VDC
TRO-TLD-D45WSO	45W hardwire 15VDC
TRO-TLD-D60WSO	60W hardwire 15VDC
TRO-TLD-D75WSO	75W hardwire 15VDC
TRO-LPV-20W-15V	15VDC 20 Watt LED power supply
TRO-LPV-35W-15V	15VDC 35 Watt LED power supply