

CODE NUMBER

12051415

DESCRIPTION

SU-1205 Urinal and SLOAN 8186 Flushometer.

COMPONENTS

- Flushometer: Code 3790068
- Urinal: Code 1101205

DETAILS

- Flush Volume: 0.5 gpf (1.9 Lpf)
- Nominal Dimensions: 14 ½" x 20 ¾" x 25 ¼" (368 x 527 x 641mm)

FLUSHOMETER FEATURES

- Vacuum Breaker with Flush Connection
- Sweat Solder Adapter with Cover Tube and Cast Wall Flange
- ¾" I.P.S. Screwdriver Bak-Chek® Angle Stop with Vandal Resistant Stop Cap
- Spud Coupling and Spud Flange for ¾" Top Spud
- "Low Battery" Flashing LED
- Courtesy Flush® Override Button
- No External Volume Adjustment to Ensure Water Conservation
- Stop Seat and Vacuum Breaker Molded from PERMEX® Rubber Compound for Chloramine resistance
- Synthetic rubber seals for chloramine resistance
- Infrared Sensor with Multiple-focused, Lobular Sensing Fields for high and low target detection
- Engineered Plastic Cover with replaceable Lens Window
- Four (4) Size AA Batteries included
- High Chloramine Resistant PERMEX® Synthetic Rubber Diaphragm with Linear Filtered Bypass and Vortex Cleansing Action™

FIXTURE FEATURES

- Wall hung vitreous top spud china
- Large footprint to cover old caulk lines
- Washdown flushing action
- ¾" I.P.S. top spud inlet
- 2" NPT outlet flange
- All mounting hardware included
- Integral flushing rim
- 100% factory flush tested
- Carrier not included



COMPLIANCES & CERTIFICATIONS



(ADA Compliant, cUPC Green Certified, WaterSense Listed, BAA Compliant, Satisfies LEED Credits, HPD, EPD)

DOWNLOADS

- [Retrofit Urinal Installation Instructions](#)
- [G2 Optima Plus Installation Instructions](#)
- [SS/ST/SU/WETS/WEUS Fixtures Repair and Maintenance Guide](#)
- [Additional Downloads](#)

NOTES

All information contained within this document subject to change without notice.

Sloan 10500 Seymour Ave, Franklin Park, IL 60131

Phone: 800.982.5839 • Fax: 800.447.8329 • sloan.com

ROUGH-IN

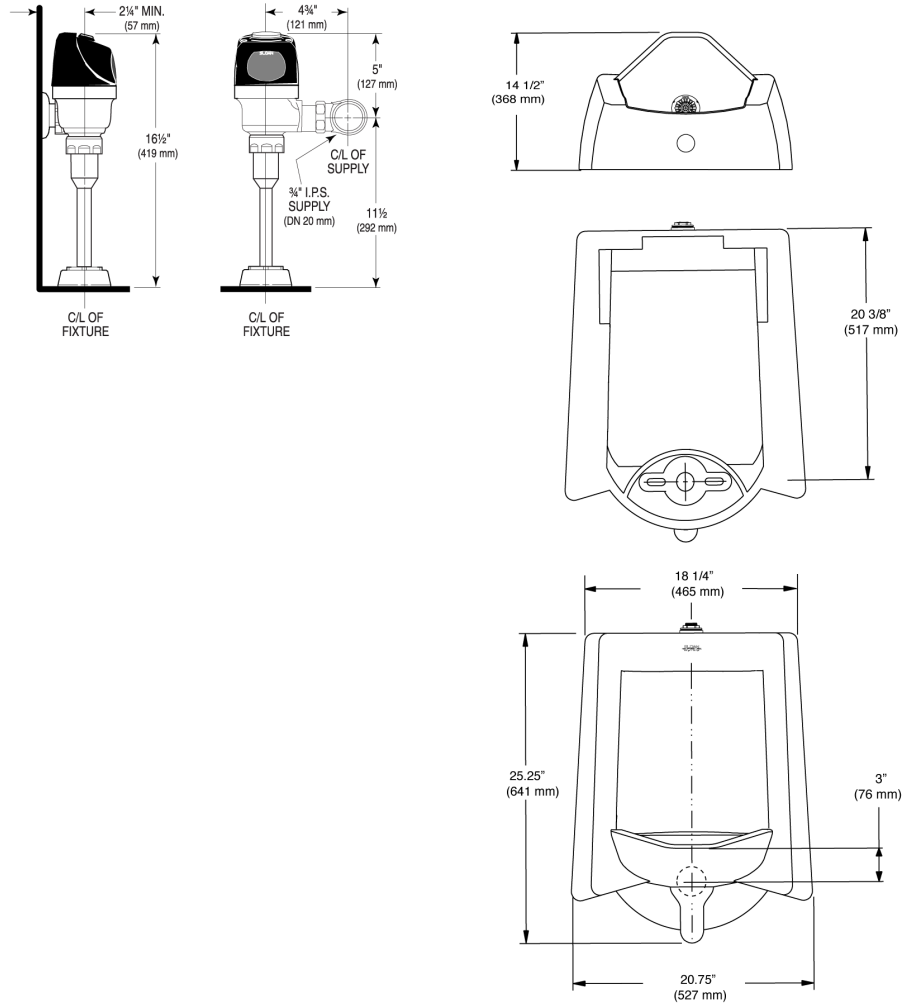

Sloan 10500 Seymour Ave, Franklin Park, IL 60131
Phone: 800.982.5839 • Fax: 800.447.8329 • sloan.com