

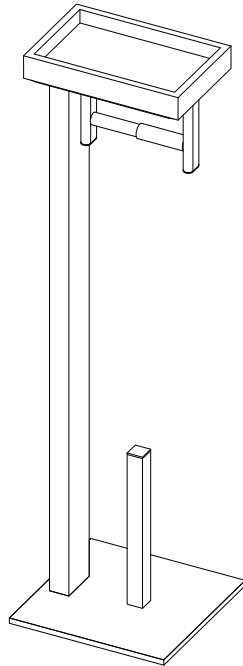









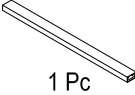

KINGSTON

KITCHEN & BATH

Pedestal Toilet Paper Holder with Storage Shelf Installation

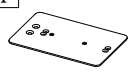

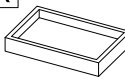
Parts:

Straight Tube(long)	Straight Tube(short)	Elliptical Tube	Washer	Bolt(long)	Bolt(short)
A  1 Pc	B  1 Pc	C  2 Pcs	D  3 Pcs	E  3 Pcs	F  2 Pcs
Screw	Screw	Plate	Bar	Storage Shelf	Gasket
G  4 Pcs	H  2 Pcs	I  1 Pc	J  1 Pc	K  1 Pc	L  4 Pcs

www.kingstonbrass.com
 TOLL-FREE CUSTOMER SERVICE: 1-877-2-KBRASS
 TECHNICAL SUPPORT E-mail: service@kingstonbrass.com
 12775 Reservoir Street, Chino, CA 91710

TOOLS REQUIRED



Allen Wrench



Phillips Screwdriver

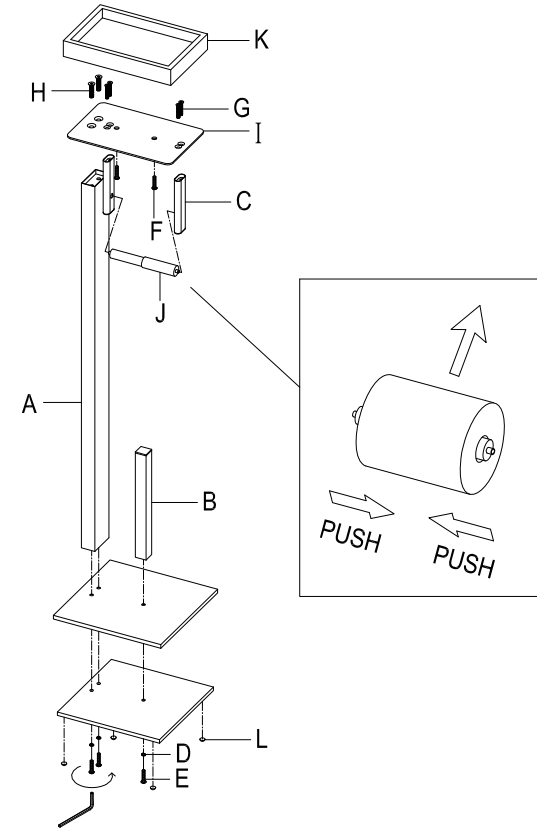

Installation Steps:

- Step 1. Place the base on a flat level surface and install straight tube (part A, B) by securing the included bolts (part E) and washers (part D) onto the bottom of the base. Tighten each bolt using an Allen wrench.
- Step 2. Install elliptical tube (part C) with hole facing inside onto the plate (part I) and secure the screws (part G) tightening with the Phillips screwdriver, then install the plate (part I) and screws (part H) into the straight tube (long) (part A) with an Allen wrench.
- Step 4. Locate the storage shelf (part K) and the bolts (short) (part F) provided, secure them into plate (part I) tightening with an Allen wrench.
- Step 5. To complete the installation, use the provided gaskets to cover the exposed corners of the bottom of the base. This helps prevent direct contact with the floorboard and extends product life.
- Step 6. Slip the toilet paper into bar (part J) and attach the bar to part C.

Cleaning

Clean with a damp cloth only.
 Avoid using metal or abrasive polishes.