

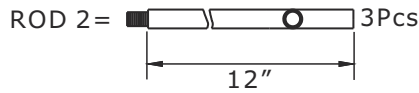

ASSEMBLY INSTRUCTION MODEL#XAV-B9304-VG-GR

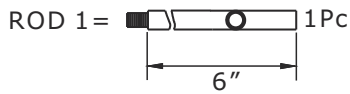

All electrical components must be installed by a licensed electrician in accordance with the National Electric Code and the appropriate local electrical codes.



You will need 4-Medium Base Bulb
40 Watts Recommended 60 Watts Max.
USE LED BULBS FOR EXTENDED USE
This fixture is Damp rated

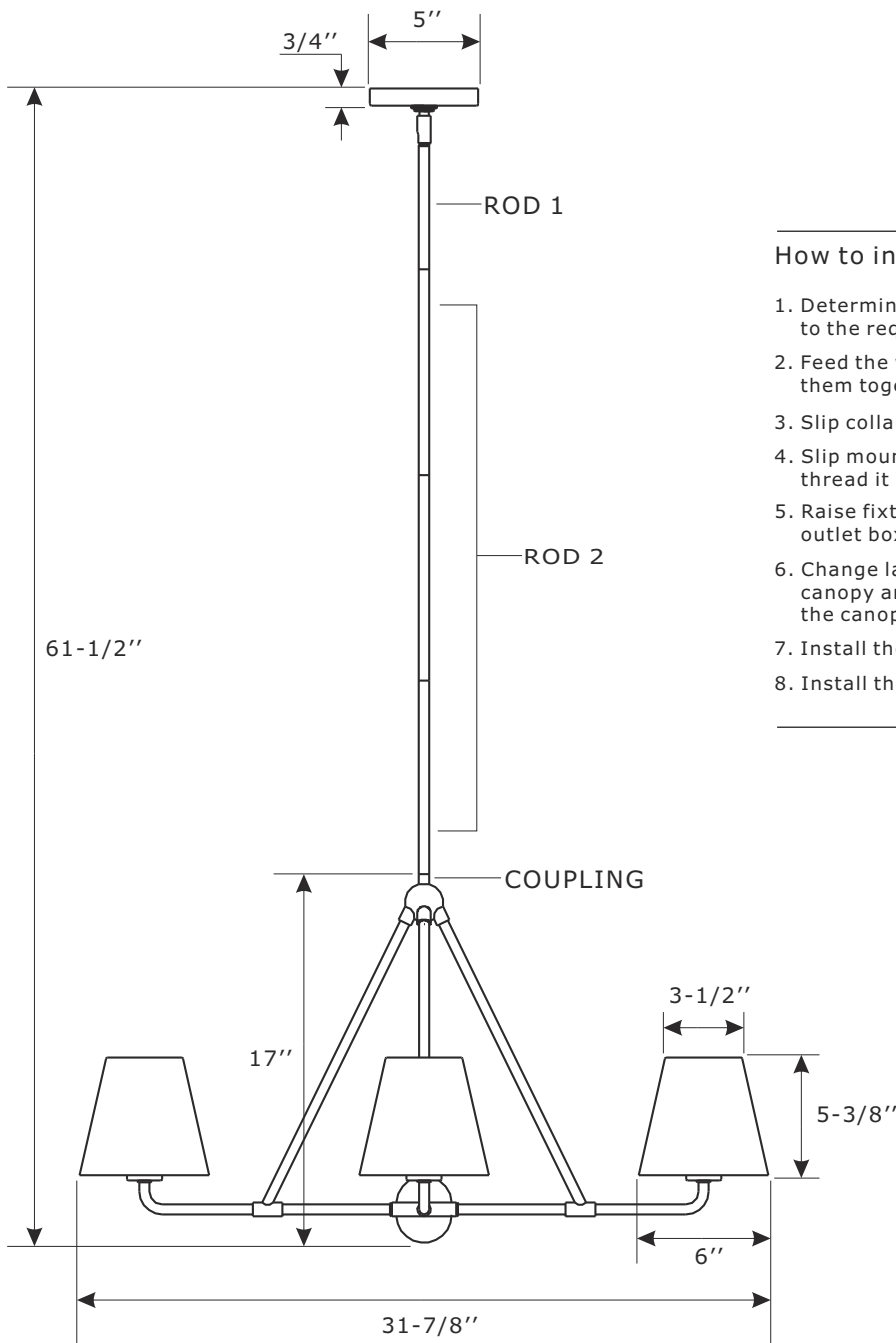

How to install

1. Determine the preferred hanging height and adjust to the required rods.
2. Feed the wires through the rods and connect them together.
3. Slip collar ring and canopy over the rod assembly.
4. Slip mounting strap with swivel along wire and thread it into the top of the rod assembly.
5. Raise fixture up and attach mounting strap to the outlet box using two outlet box screws.
6. Change last sentence to slide collar ride up to canopy and thread it onto the screw collar, securing the canopy.
7. Install the metal shade onto the socket.
8. Install the bulb(not included) into the socket.



ASSEMBLY INSTRUCTION MODEL#XAV-B9304-VG-GR

Part Number

Part Numbers

- A. (1)-Mounting hardware
- B. (1)-Canopy W5"xH3/4" #XRF9302VGCAN5IN
- C. (1)-Collar ring
- D. (1)-Rod D1/2"xL6" #XRF9302VGROD6IN
- E. (3)-Rod D1/2"xL12" #XRF9302VGROD12IN
- F. (4)-Metal shade #XRF8321GRSHA6IN
- G. (4)-Socket

